

# Инструкция по установке **KIA SELTOS** (2020-)

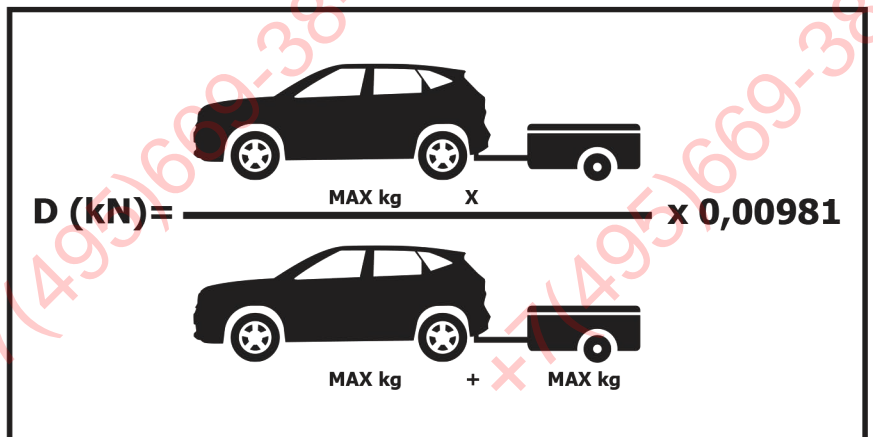

Арт.: F.2816.001

Тип шара - «А»

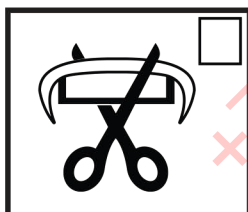
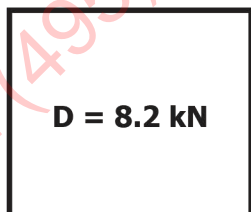
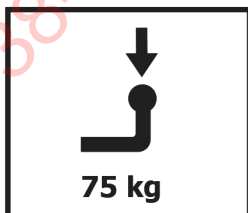
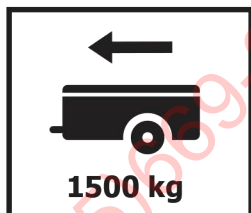

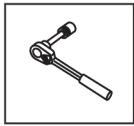

Вкрутить/выкрутить используя инструмент

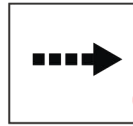

Движение



Поворот



Вкрутить/выкрутить не затягивая

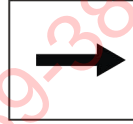





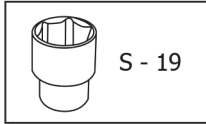
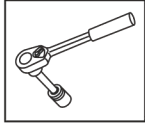

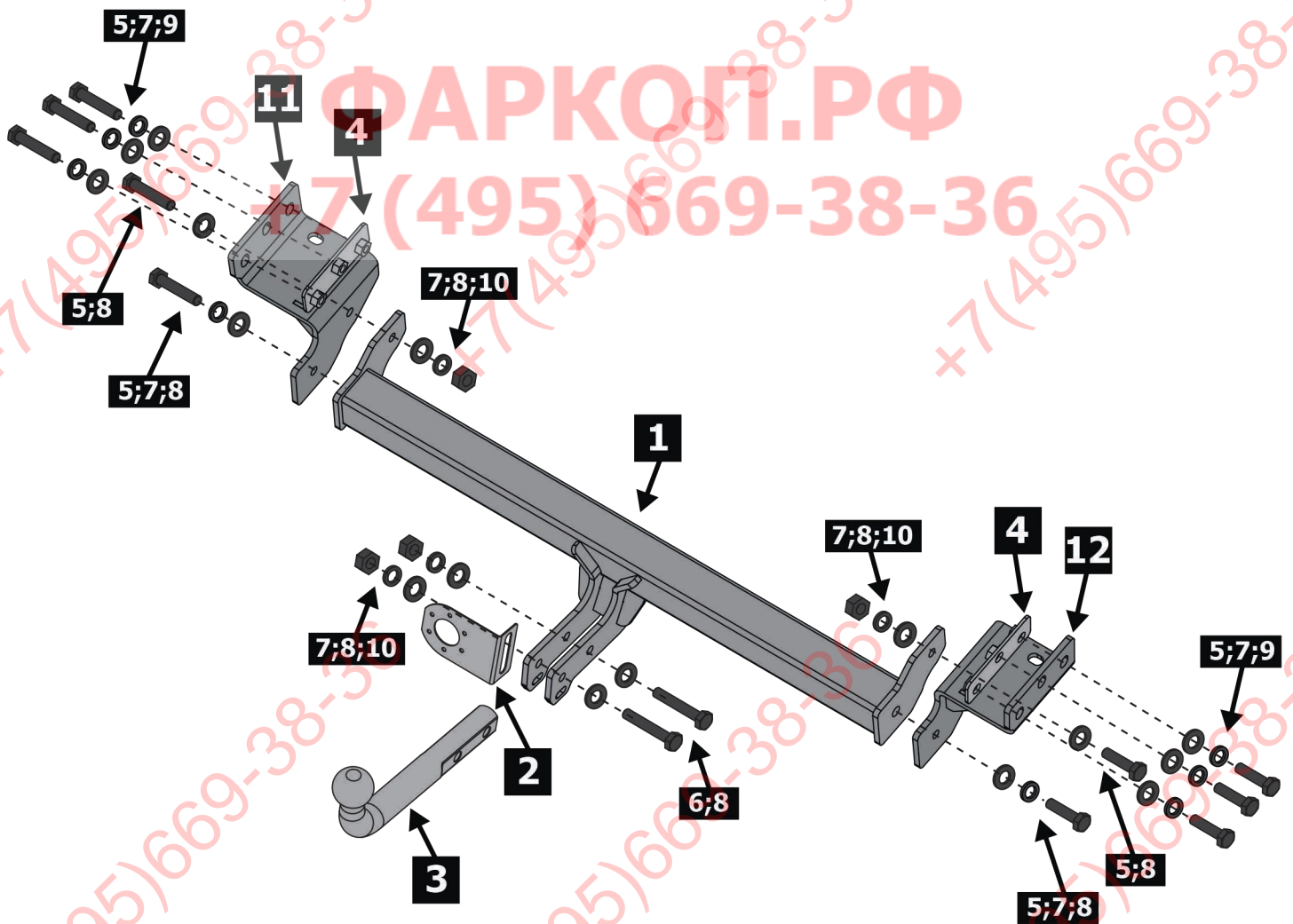

Расположение

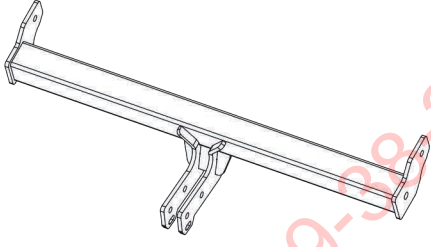
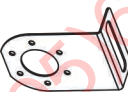
### Используемый инструмент:

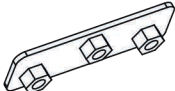
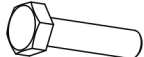

S - 19

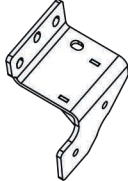
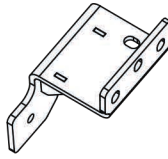

<b>1</b>	x1	Балка	
<b>2</b>	x1	Подрозетник	
<b>3</b>	x1	Крюк	
<b>4</b>	x2	Закладная пластина	
<b>5</b>	x10	M12x1,25x40	
<b>6</b>	x2	M12x1,25x70	
<b>7</b>	x12	∅ 12	
<b>8</b>	x10	∅ 12	
<b>9</b>	x6	∅ 12	
<b>10</b>	x4	M12x1,25	
<b>11</b>	x1	Кронштейн правый	
<b>12</b>	x1	Кронштейн левый	

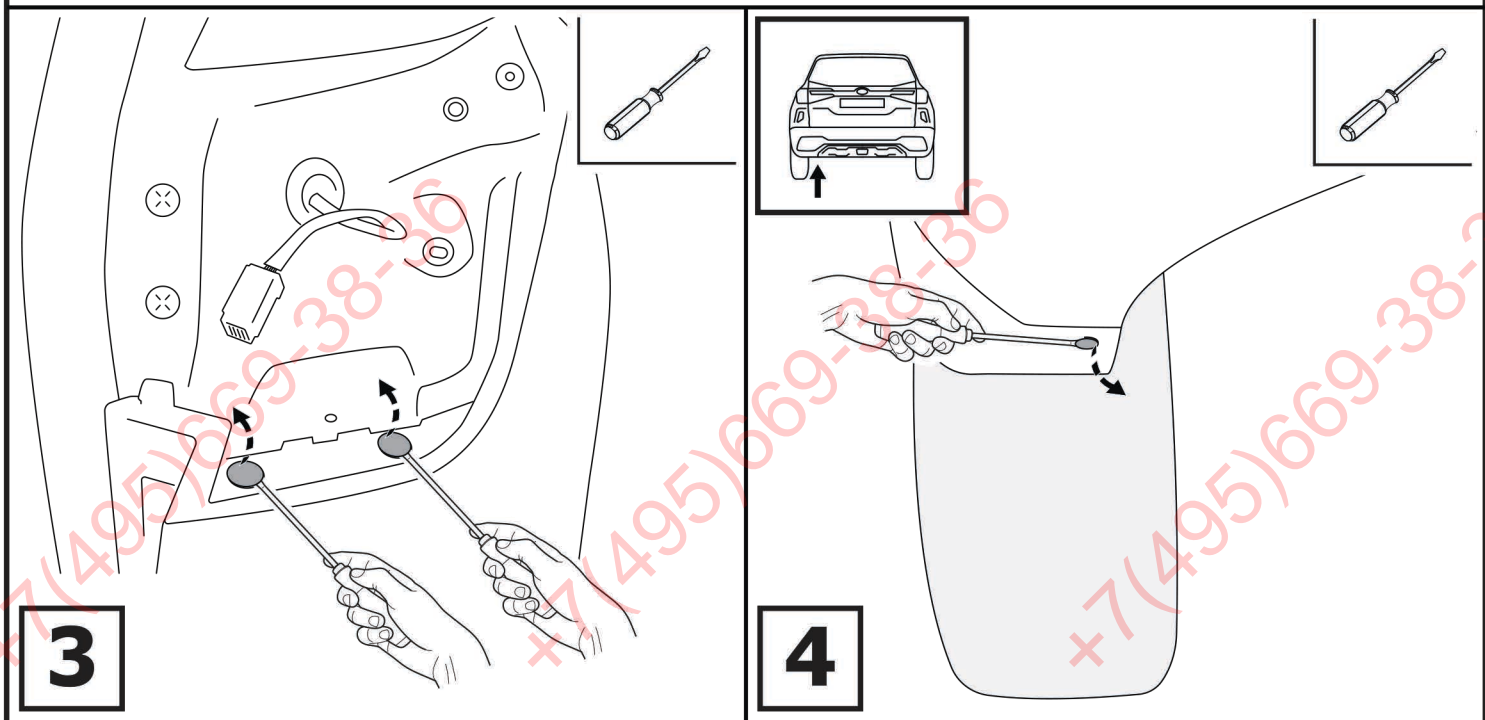
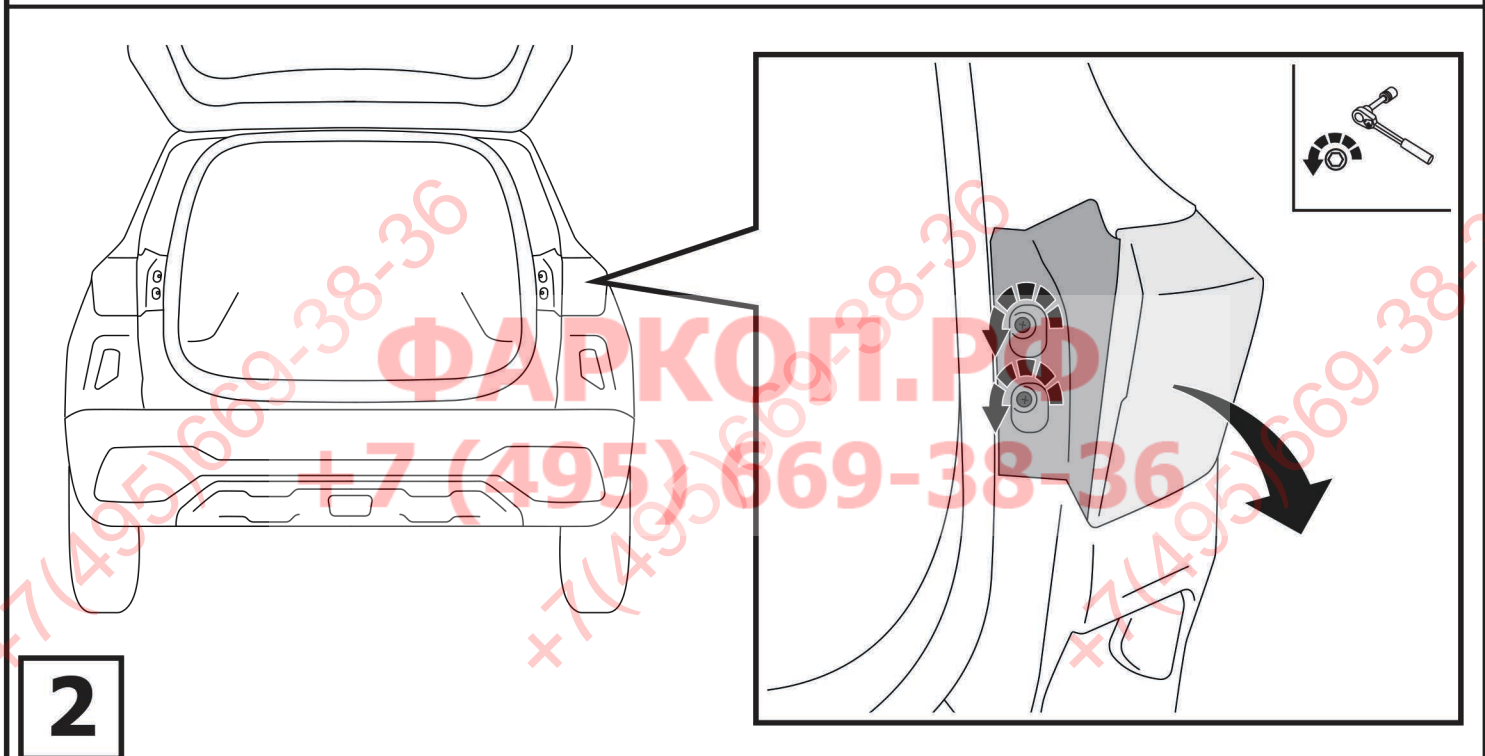
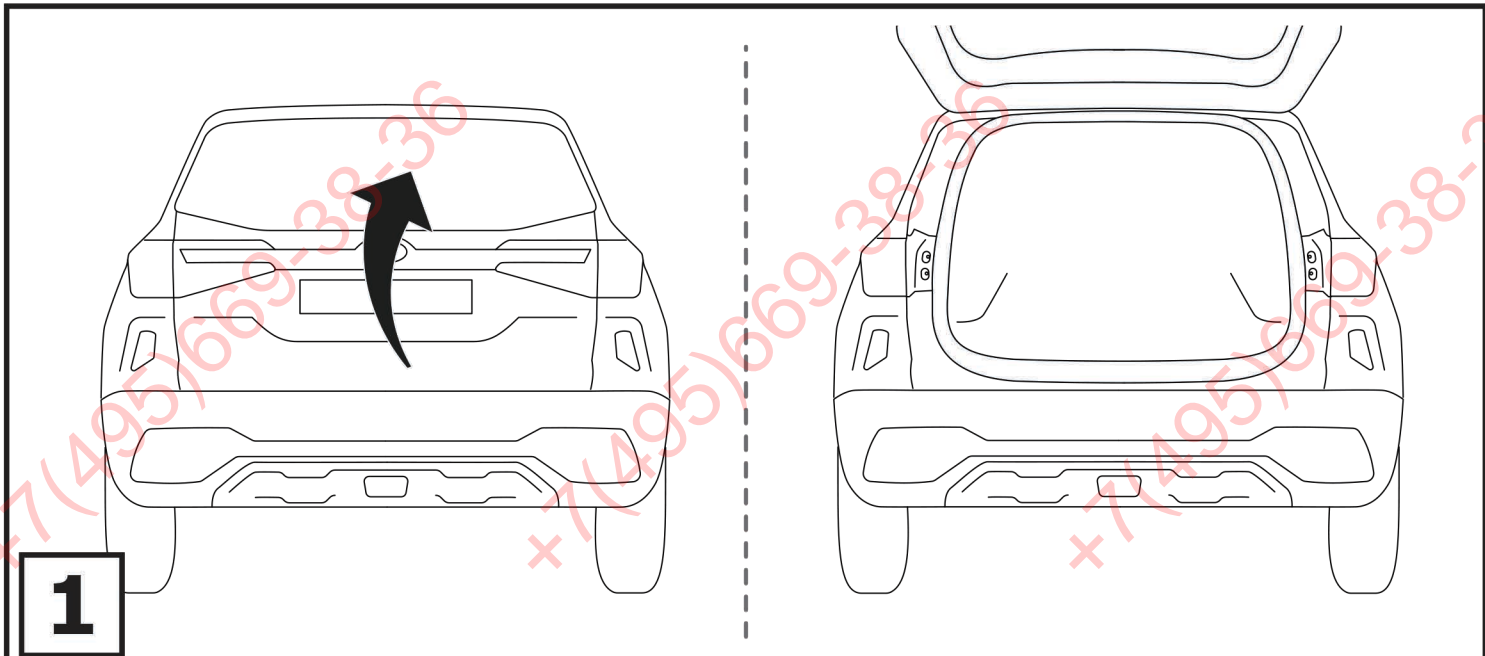

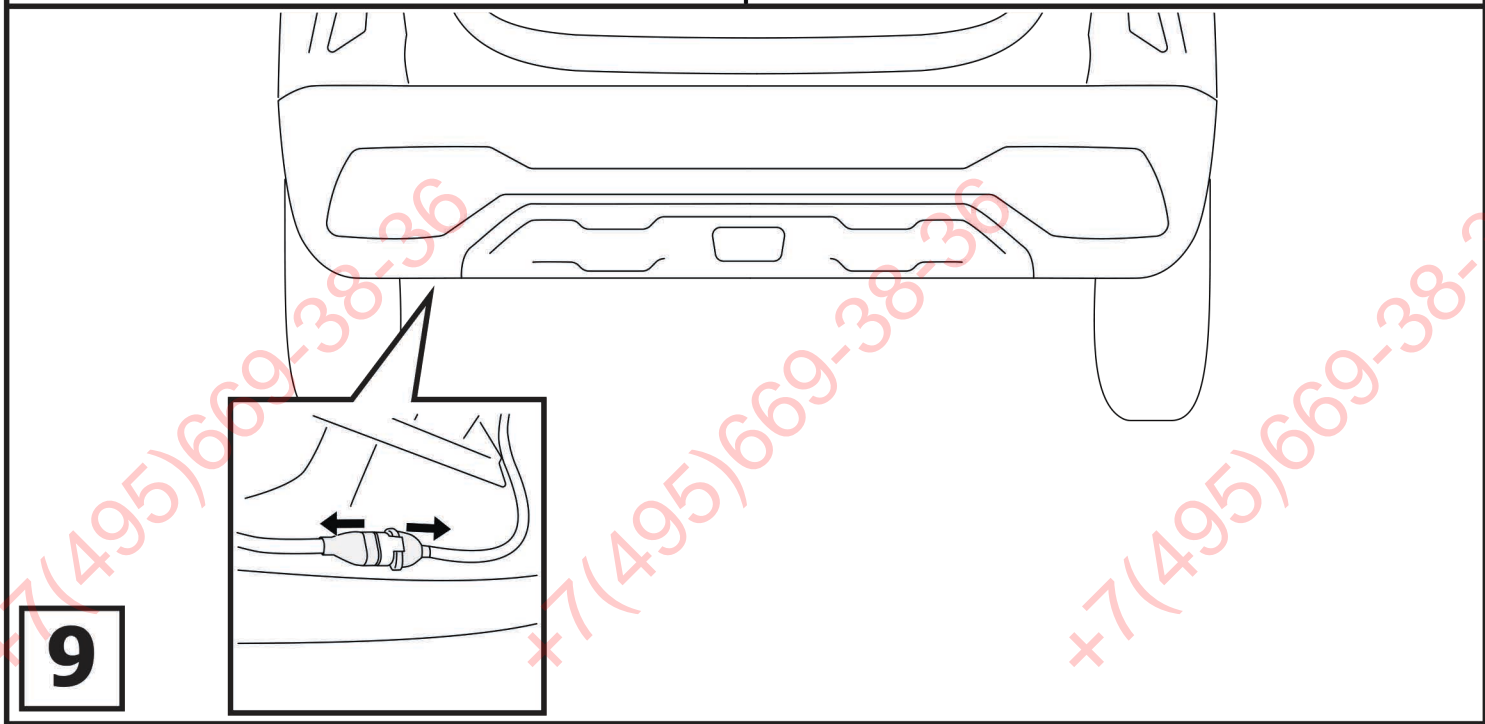
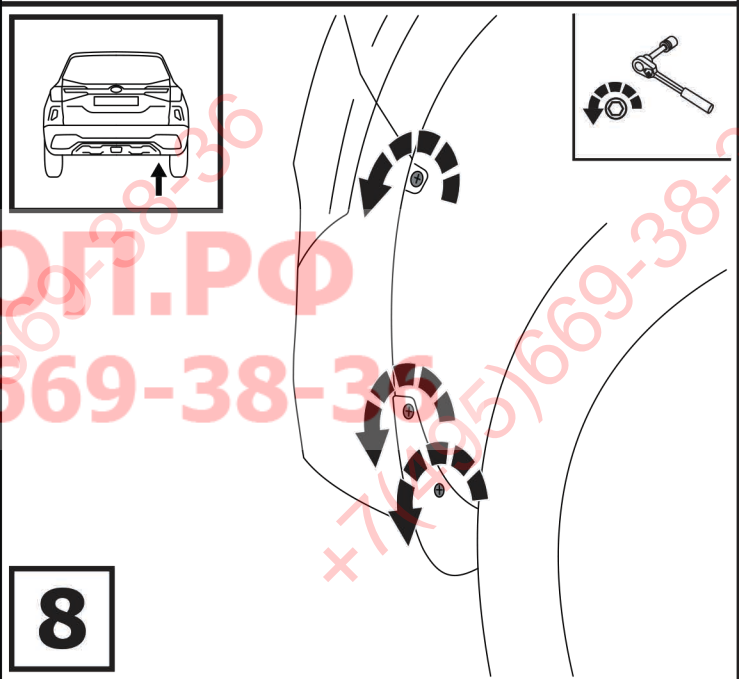
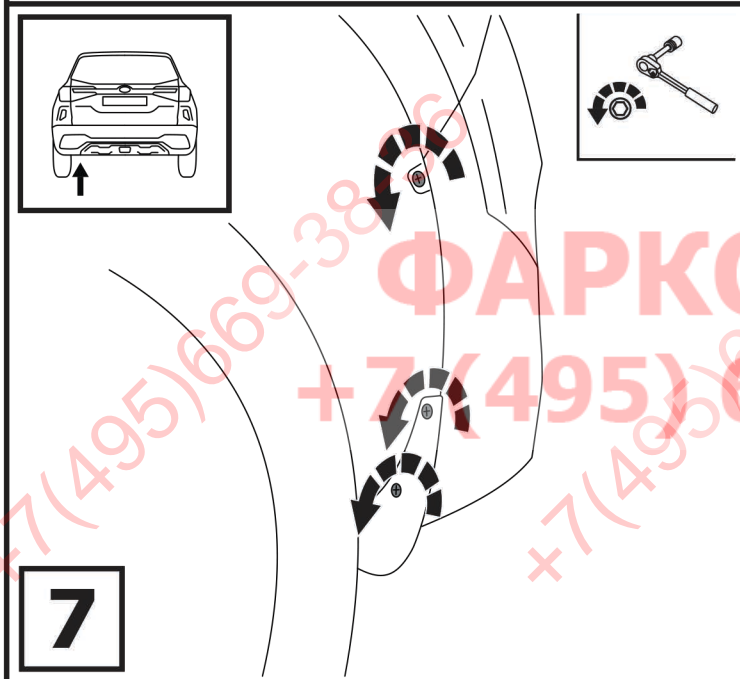
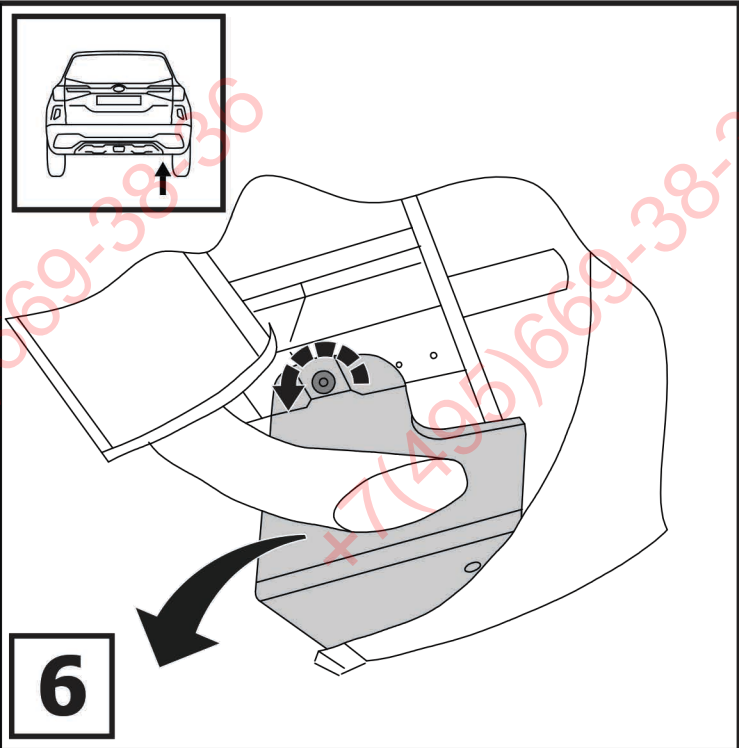
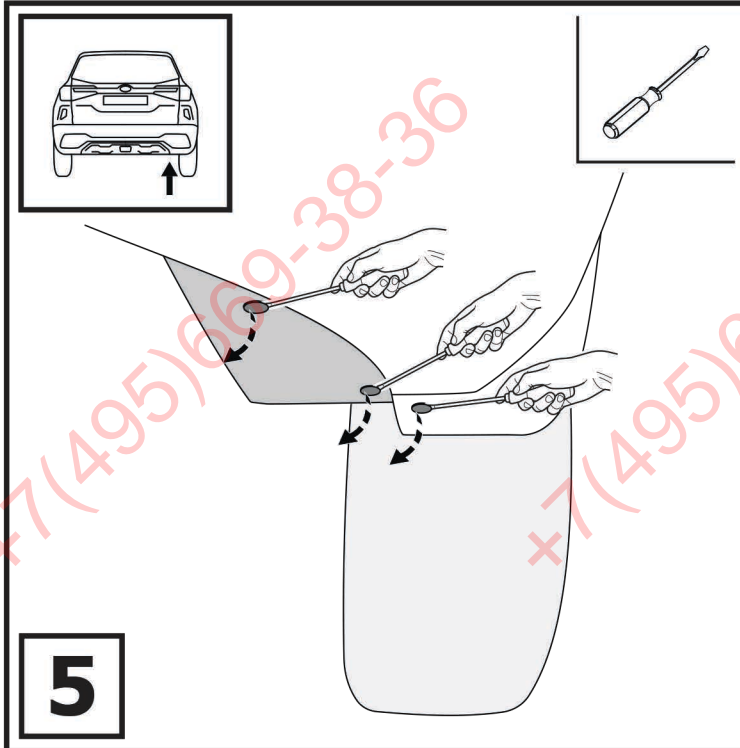

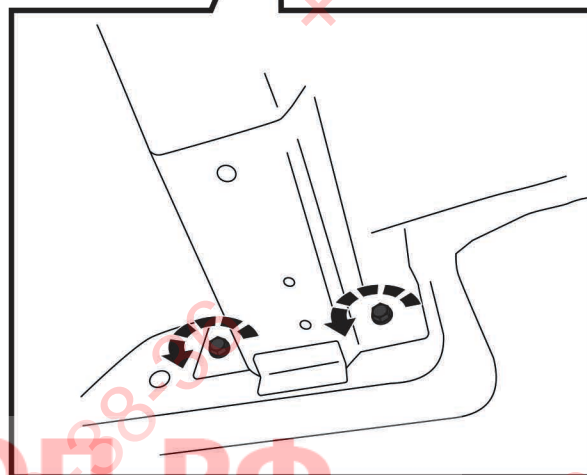
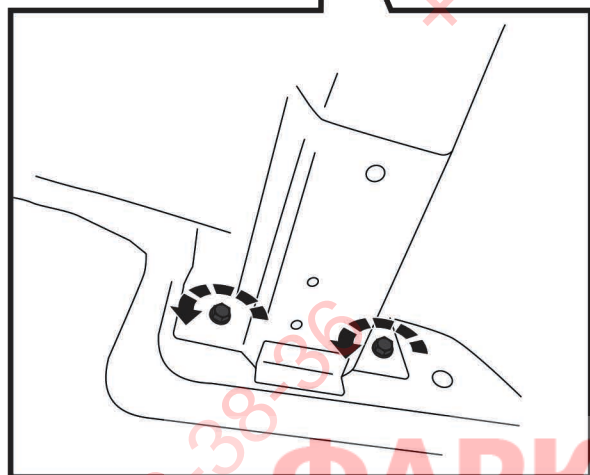
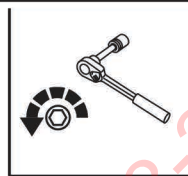

**ФАРКОЛТ.РФ**

**+7 (495) 669-38-36**

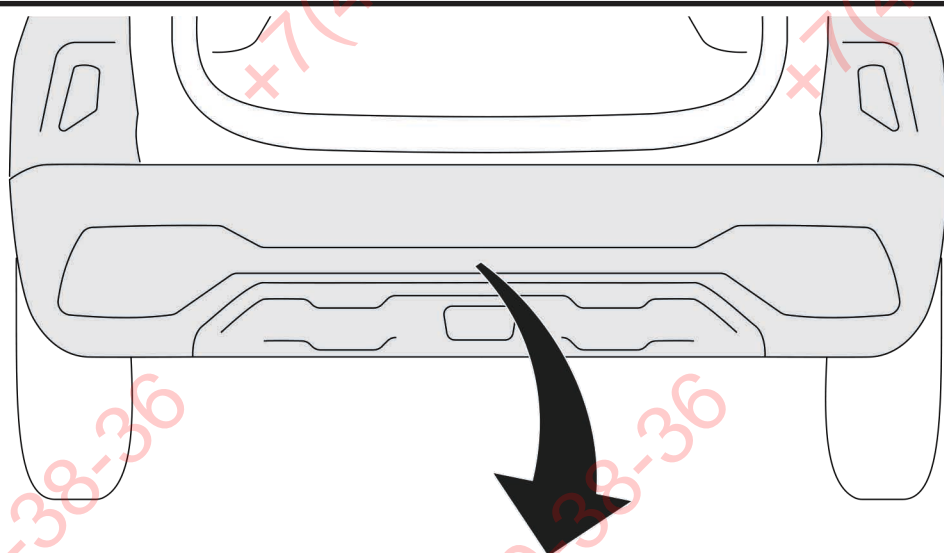

**9**

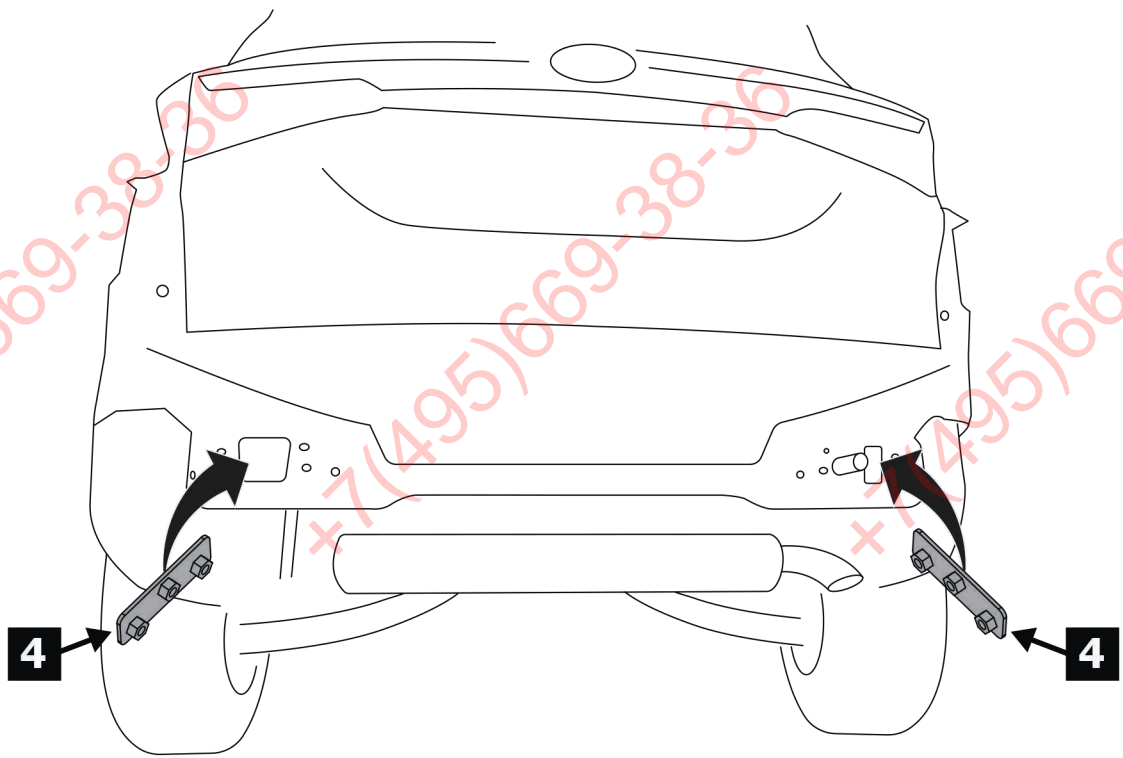

**10**

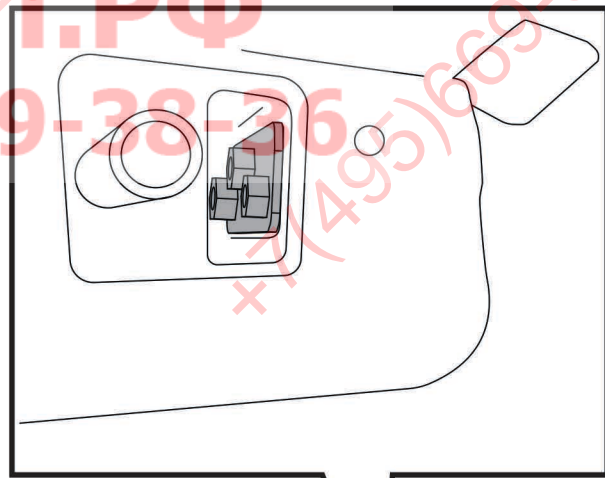
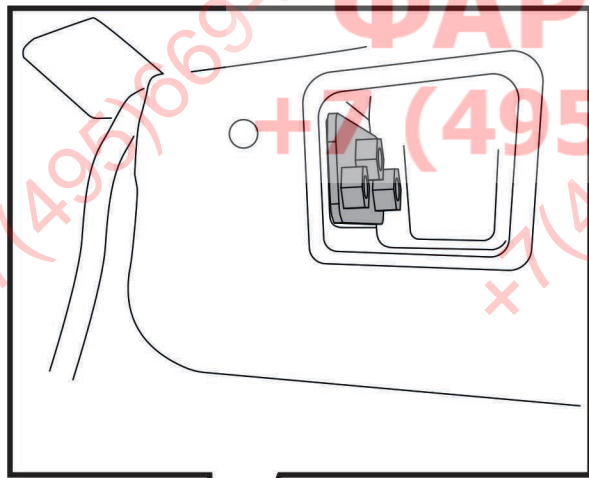
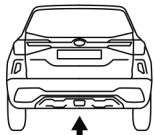

**ФАРКОЛ.РФ**

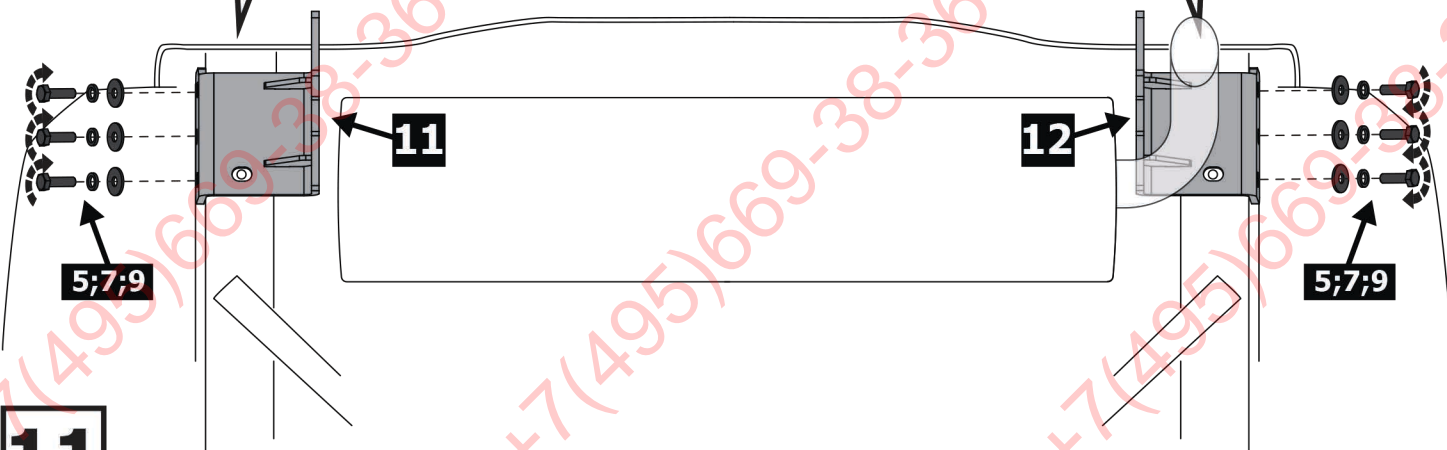

**11**

